

Triángulo 6. Zamak niquelado. **03016T**

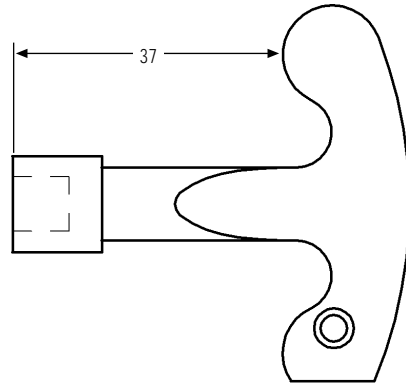

Triángulo 7. Zamak niquelado. **03017T**

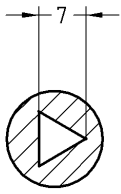
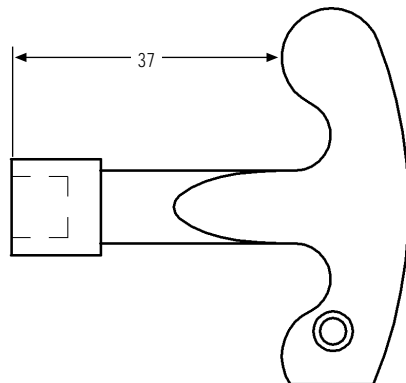
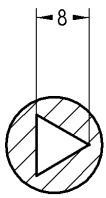

Triángulo 8. Zamak niquelado. **03018T**

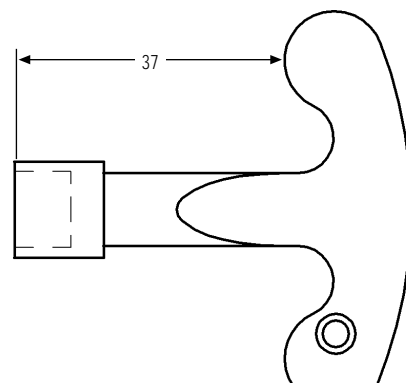
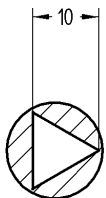

Triángulo 10. Zamak niquelado. **030110T**



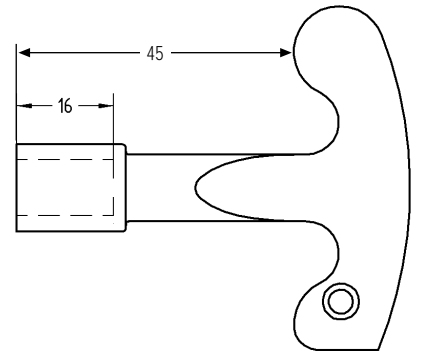
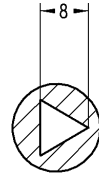

03018TF

Triángulo 8 flotante. Zamak niquelado.

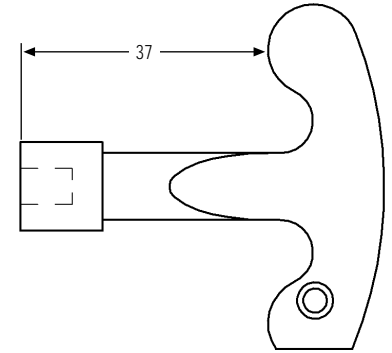
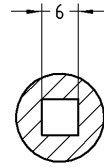

03016C

Cuadrado 6. Zamak niquelado.

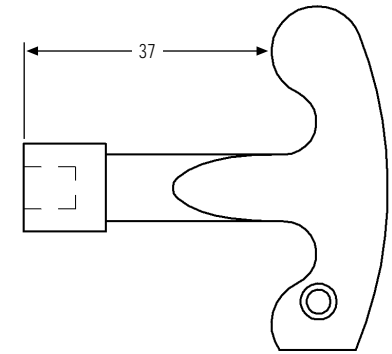
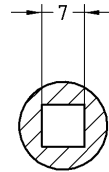

03017C

Cuadrado 7. Zamak niquelado.

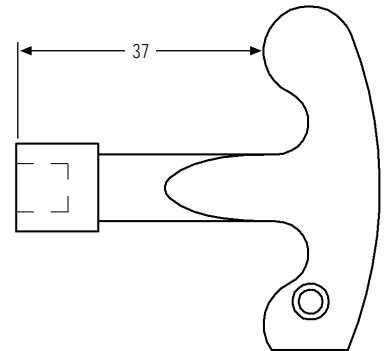
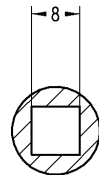

03018C

Cuadrado 8. Zamak niquelado.



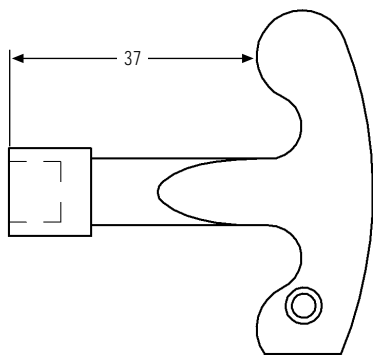
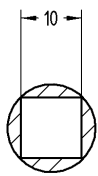

Cuadrado 10. Zamak niquelado. **030110C**

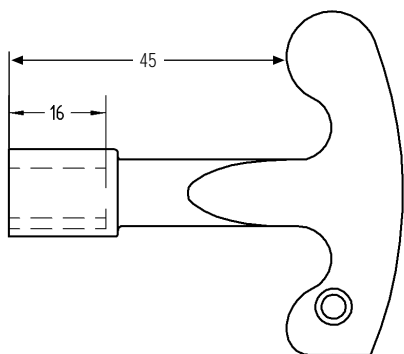
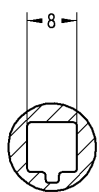

Cuadrado 8 con canal. Zamak niquelado. **03018CC**

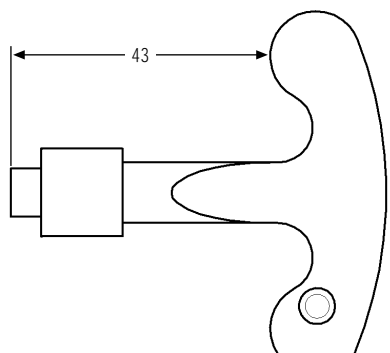
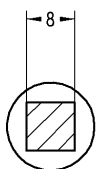

Cuadrado macho 8. Zamak niquelado. **03018CM**

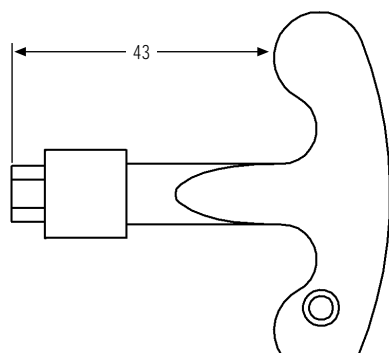
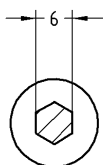

Hexágono macho 6. Zamak niquelado. **03016HM**



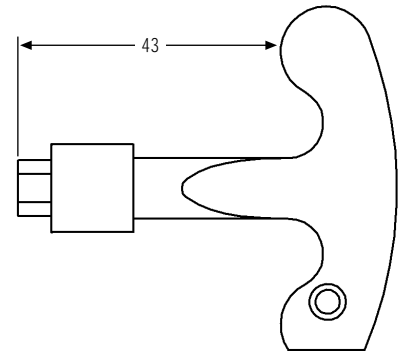
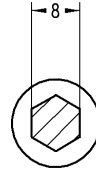

03018HM

Hexágono macho 8. Zamak niquelado.

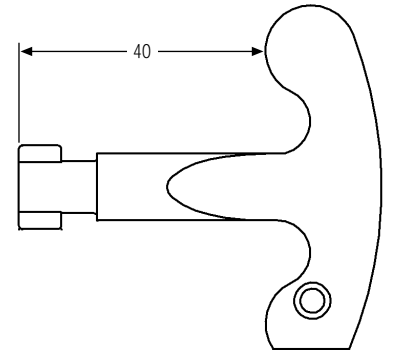

0301DP

Doble pala. Zamak niquelado.

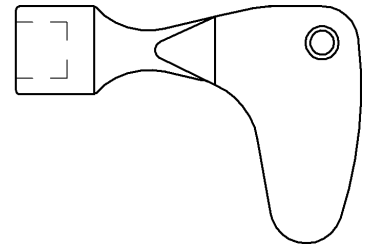
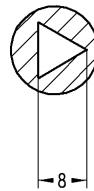

03028T

Triángulo 8. Zamak niquelado.

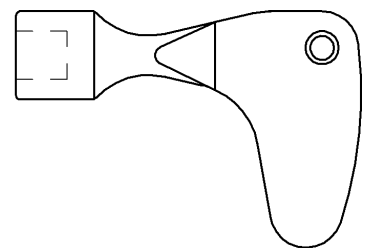
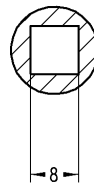

03028C

Cuadrado 8. Zamak niquelado.



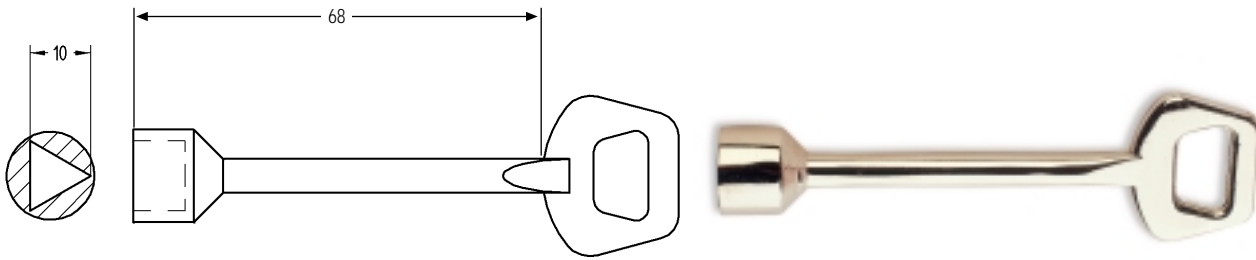

Triángulo 10. Zamak niquelado. **030310T**

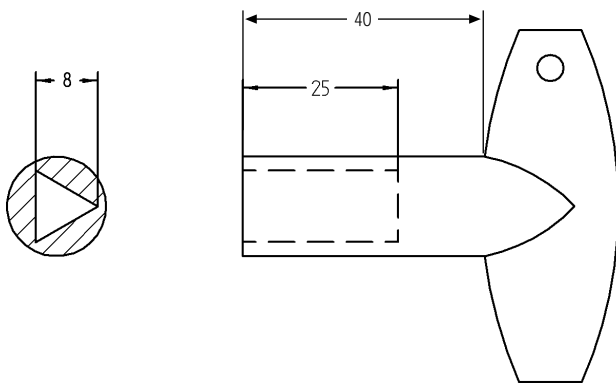

Triángulo 8 flotante. Poliamida gris. **050TF**

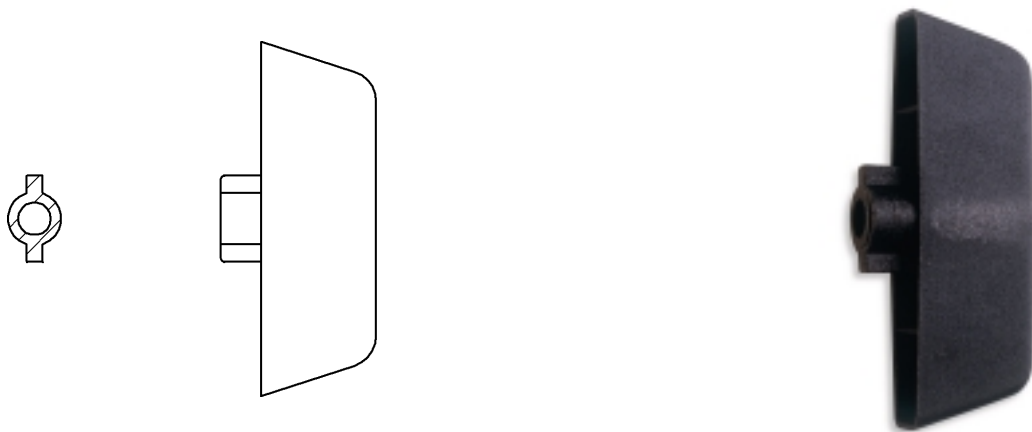

Doble pala. Poliamida negra. **059DP**

